

TAMAÑO ESTÁNDAR

Referencia	CABINA			TOTAL			
	Largo	Ancho	Alto	Largo	Ancho	Alto	
Estándar 3,00 x 1,50	99028/01	3,00	1,50	2,40	3,00	1,50	3,05

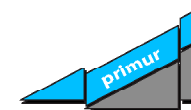

PRIMUR S.A.
PROYECTOS E INSTALACION
DE MATERIAL URBANO

CABINA DE PEAJE AUTOPISTA

Cabina de Peaje

Tamaño Estándar

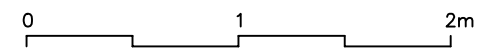
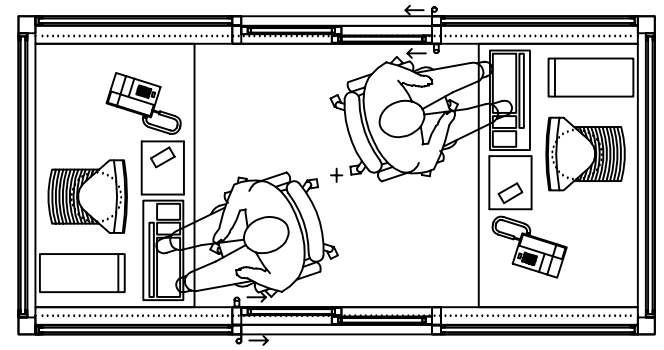
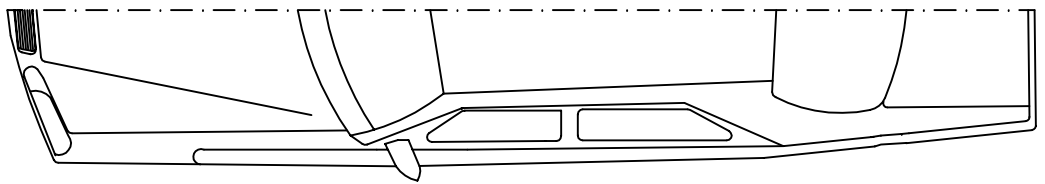
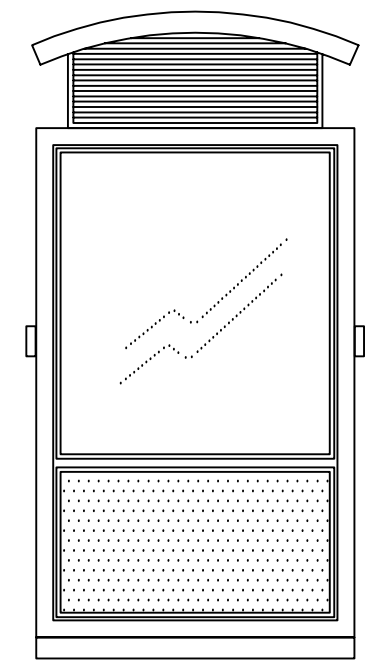
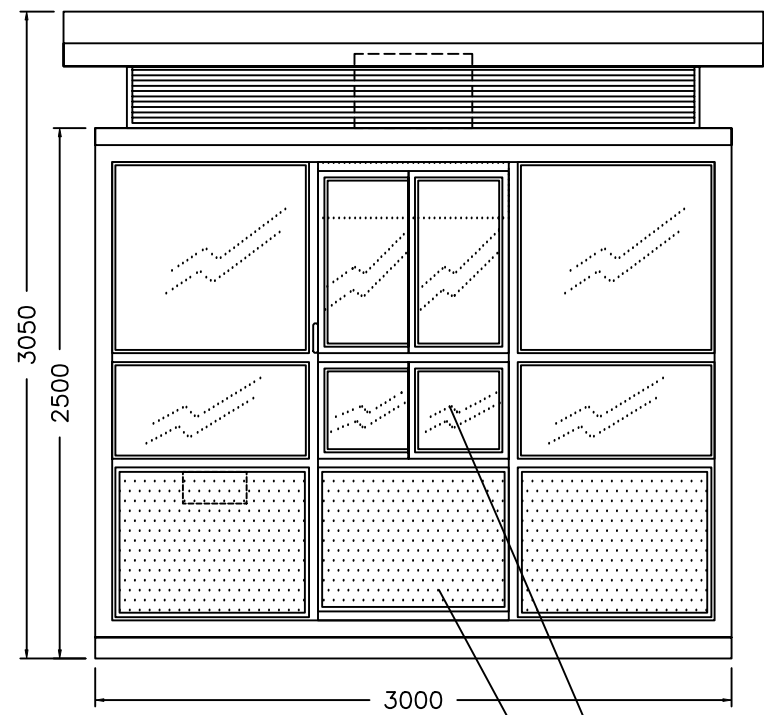
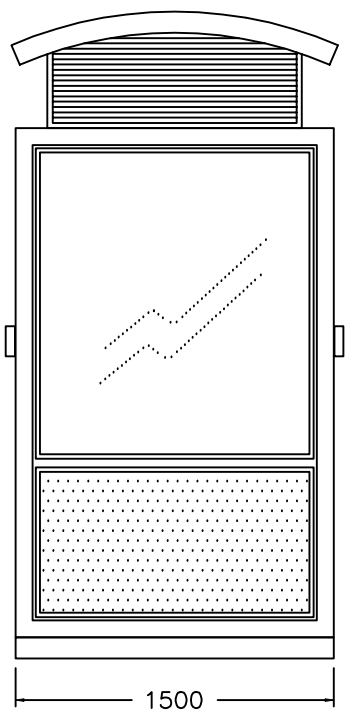
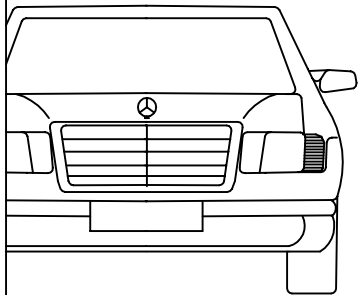

MOBILIARIO NO SUMINISTRADO - COTAS ORIENTATIVAS, EN MILIMETROS

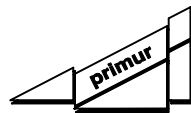

PRIMUR S.A.
PROYECTOS E INSTALACION
DE MATERIAL URBANO

Telefono 98/5323200
GUJON . ASTURIAS

Encargo PRIMUR S.A.

Obra CABINA DE PEAJE MODELO 'AUTOPISTA'
ATENCION A 2 LADOS

	Fecha	Nombre	ESCALAS	Plano N°
Dibujado	13.2.2001	R.RIESTRA	1/25	99028/03
Comprobado				
Sustituye a:	Sustituido por:	Revision:		NUM. CAD:
3.3.1999		1		PEAJE028